

# AVAYA

USER GUIDE  
**AWH75**  
PROFESSIONAL HEADSET SYSTEM



# AVAYA

© 2006 Plantronics, Inc. All rights reserved. Avaya and the Avaya Logo are trademarks of Avaya, Inc. and may be registered in certain jurisdictions.

IntelliStand, SupraElite, and the voice tube clear color trade dress are trademarks or registered trademarks of Plantronics, Inc.

Patents U.S. 5,210,791; 6,735,453; D469,756; D505,413; D512, 984; Australia 147229; France 651,857-651,865; Germany 40108524.4; GB Regd.Des.No. 2104923 and Patents Pending

Printed in China

73870-01 (05.06)

# Table of Contents

Components	3
Setup 1–5	6
IntelliStand	10
Charging	11
Positioning	11
Adjusting Fit	12
Multi-shift Pairing	12
Making/Answering/Ending Calls	13
Checking Compatibility	15
Volume	16
Headset Controls	18
Base Indicator Lights	19
Troubleshooting	20
Subscription	22
System Reset	22
Maintenance	22
Voice Tube Replacement	22
Battery Replacement	23
Accessing UCC	24
Technical Assistance	25
Regulatory Notices	25

# Components

## Headset

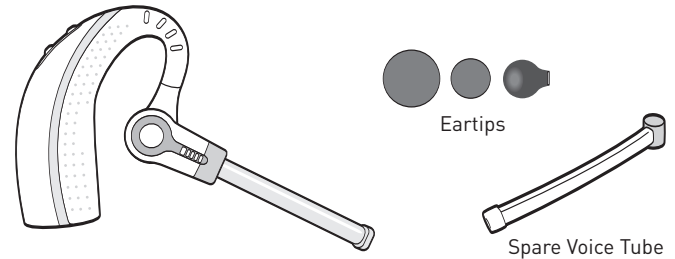

## Base

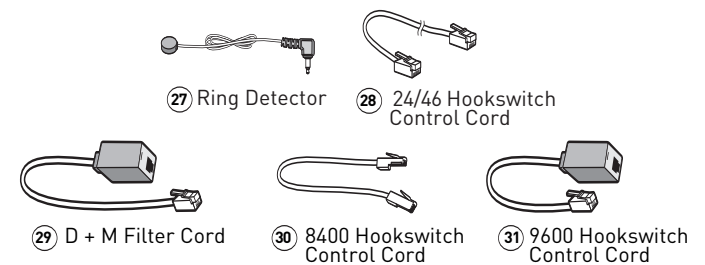
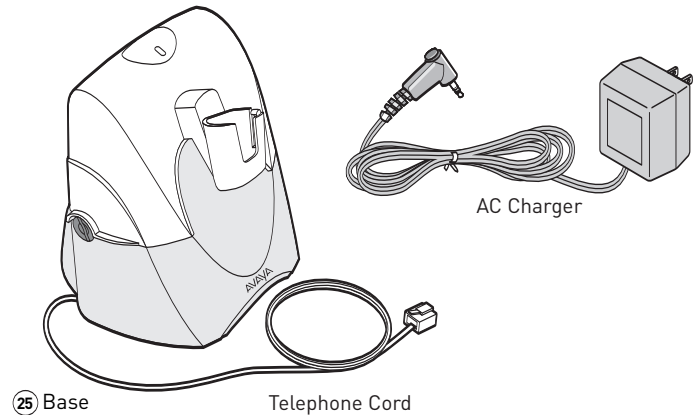

# Components

## Base - Top View

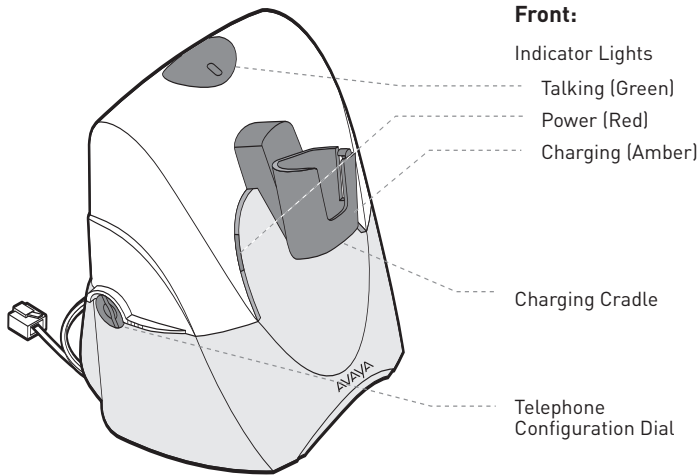

### Front:

- Indicator Lights
  - Talking (Green)
  - Power (Red)
  - Charging (Amber)
- Charging Cradle
- Telephone Configuration Dial

### Rear:

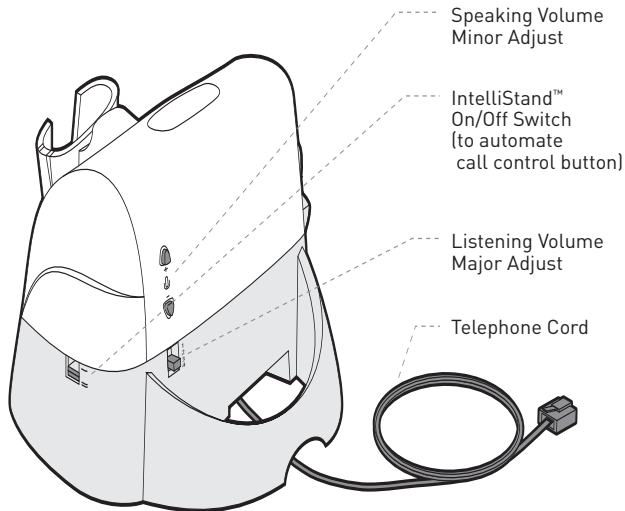

- Speaking Volume Minor Adjust
- IntelliStand™ On/Off Switch (to automate call control button)
- Listening Volume Major Adjust
- Telephone Cord

# Components

## Base - Underside View

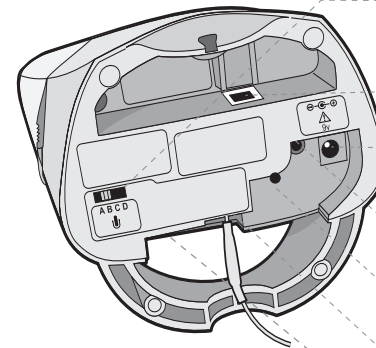

- Speak Volume Major Adjust
- Handset Jack
- AC Power Adapter Jack
- Accessory Jack
- Ring Detector Jack
- Telephone Base Jack
- EU24/ADJ

## Headset

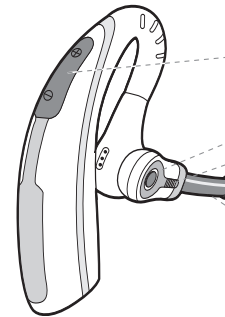

- Listening Volume/Mute
- Call Control Button
- Talk Indicator Light
- Voice Tube

**NOTE:** Please refer to the separate Safety Instructions booklet for important product safety information prior to installation or use of the product.

# Setup 1

with AVAYA 2420, 4610SW, 4620, 4620SW, 4621SW, 4622SW, 4625SW 4630SW, 5420, 5610 and 5620 telephones\*

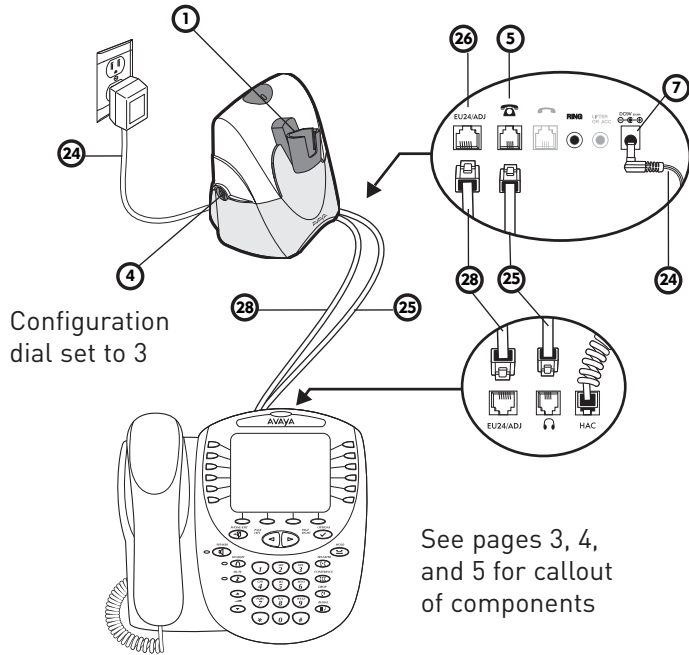

\*24xx and 54xx phones require 4.0 firmware or greater.  
46xx and 56xx phones require 1.8 firmware or greater.

# Setup 2

with AVAYA 2410, 4630, 5410, 6416 D+M and 6424 D+M telephones

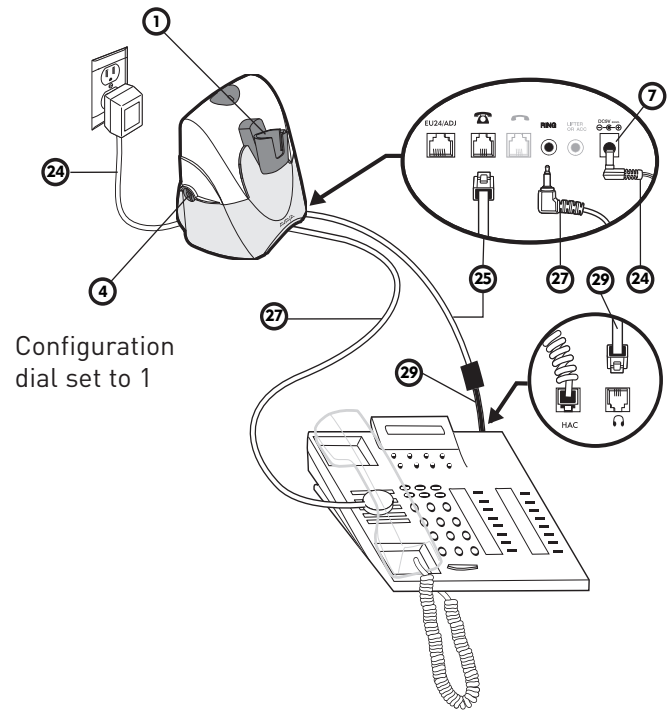

# Setup 3

with AVAYA 7403D, 7405D, 7407D, 7406, 8403, 8405, 8410D, 8411D, 8434, 8510ISDN and 7506ISDN telephones

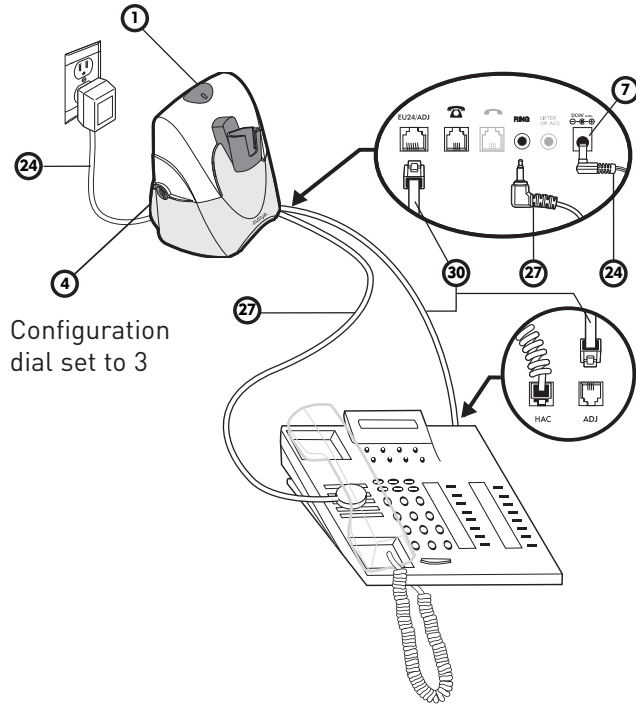

# Setup 4

with AVAYA 9600 series telephones

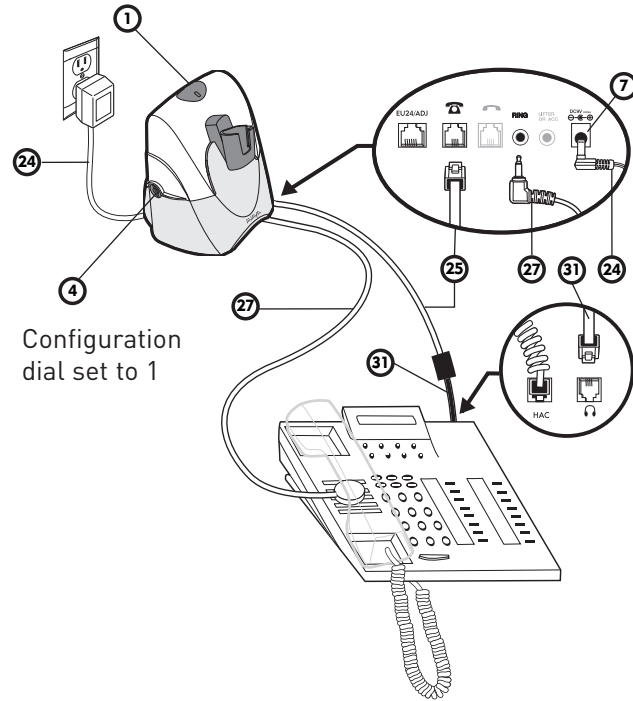

## Setup 5 with other AVAYA telephones

**Caution:** It is important for correct and safe operation that the base cord is installed into the proper jack of your telephone. Follow these instructions carefully, especially if your telephone has two jacks where the handset was attached. Be sure to note or mark which jack was used for the handset.

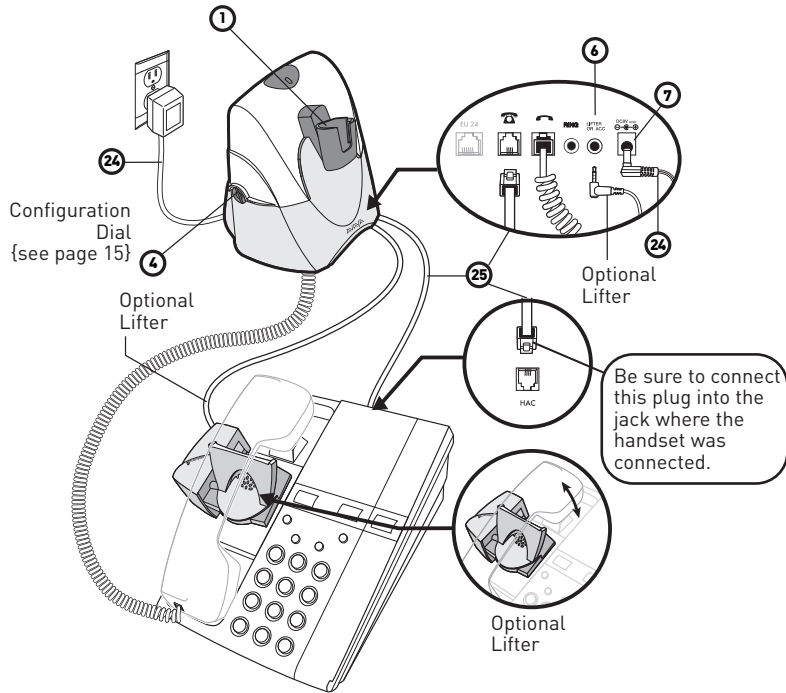

## IntelliStand™

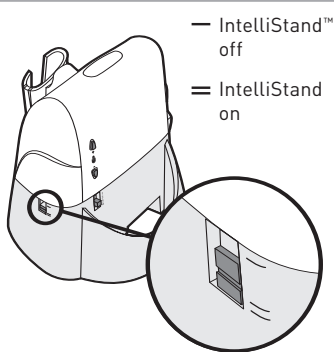

- IntelliStand™ off
- == IntelliStand on

Set the IntelliStand switch to IntelliStand off (—) if you want to control the handset lifter with the call control button on your handset.

Set the IntelliStand switch to IntelliStand on (==) if you want the handset to automatically pick up when you take the headset off the charging cradle.

## Charging



1. Slide the headset into the charging cradle. The earpiece with the microphone goes into the cradle.
2. Gently press down on the the headset to ensure that the headset is in the correct position. The amber charge indicator light on the base will flash while charging and will change to solid amber when fully charged.

- 20 minutes = minimum charge to continue setup
- 3 hours = full charge

## Positioning

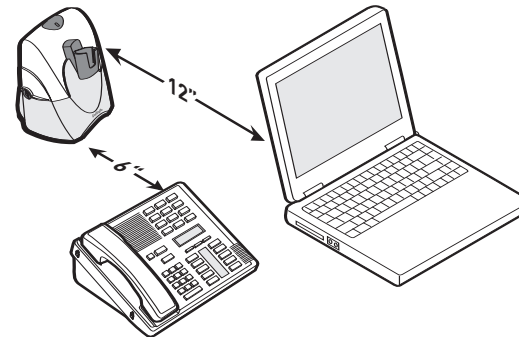

The **minimum** recommended separation distance is shown above.

**IMPORTANT:** Incorrect positioning can cause noise and interference problems.

## Adjusting Fit

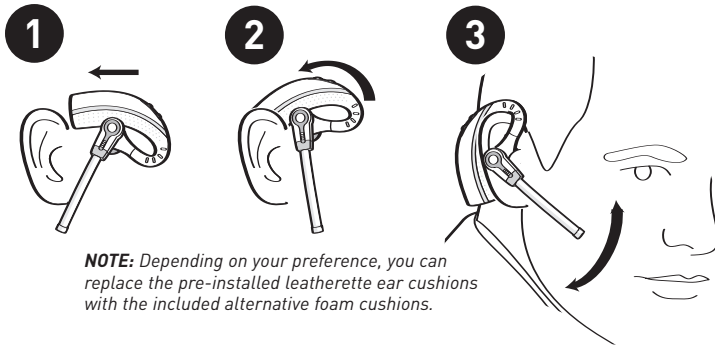

1. Adjust headband to fit.
2. Rotate noise-canceling microphone until it is pointed towards your chin.

## Multi-shift Pairing

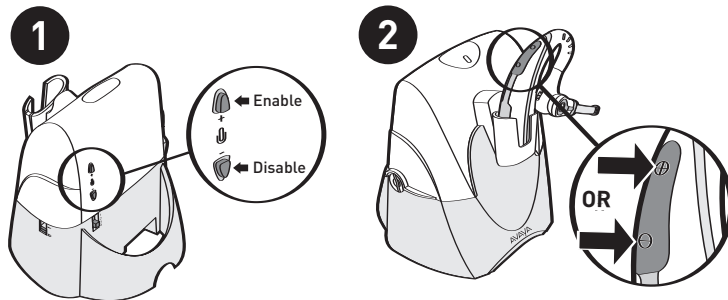

To make a call:

1. Take your handset off-hook. Dial tone should sound through handset (if not, check compatibility—see page 15).
2. Press the call control button on the headset. The talk indicator lights on both the base and the headset should go on, indicating a successful link. Dial tone should sound through headset. Dial using the telephone keypad.

To answer a call:

1. Take the handset off-hook.
2. Press the call control button on the headset to answer a call.

To end a call, press the call control button on the headset, then hang up the handset.

**NOTE:** If either you or the recipient have trouble hearing, please check compatibility (page 15).

## Making/Answering/Ending Calls

### Setup 1, 2, 3 & 4

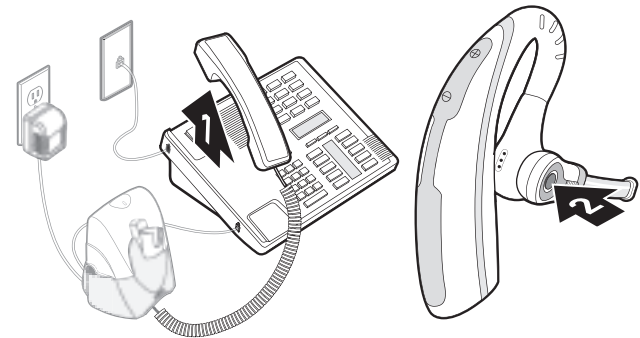

To make a call, press call control button. Dial tone should sound through handset (If not, check compatibility—see Setup 1, 2, 3 & 4). Dial using the telephone keypad.

To answer a call, press the call control button on the headset.

To end a call, press the call control button on the headset. If either you or the recipient have trouble hearing, please check compatibility (Setup 1, 2, 3 & 4).

# Making/Answering/Ending Calls

## Setup 5 with Optional Handset Lifter

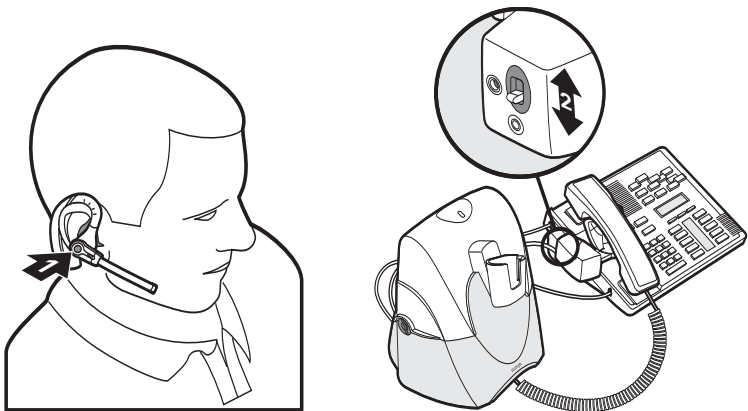

First, test proper set up of the handset lifter.

1. Press the call control button on headset to activate handset lifter and lift handset from phone. Dial tone should sound if the handset is raised high enough.
2. If no dial tone, adjust handset lifter height switch or reposition the lifter under the handset.

Use mounting tape to secure the handset lifter in position.

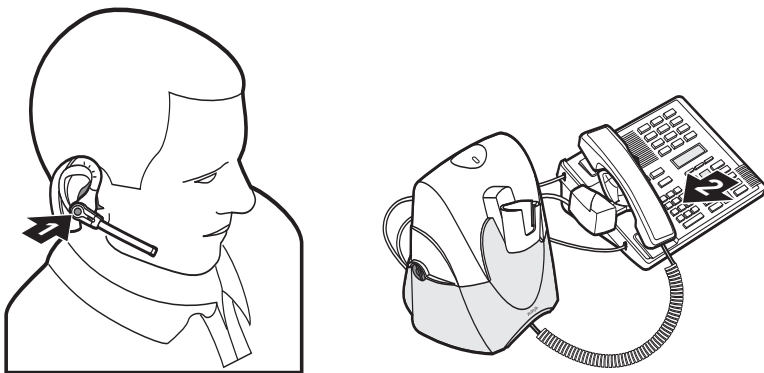

To make/answer a call:

1. Press the call control button to raise the handset lifter.
2. Use the telephone keypad to dial the number.

To end a call, press the call control button to lower the handset lifter. The handset will return to the base.

*If either you or the recipient have trouble hearing, please check compatibility (page 15).*

# Checking Compatibility

*NOTE: The compatibility setting of "1" is set at the factory to work with most phones. However, if you do not hear a dial tone, if either you or the recipient is having trouble hearing, or if you experience buzzing/hissing, please follow the directions below.*

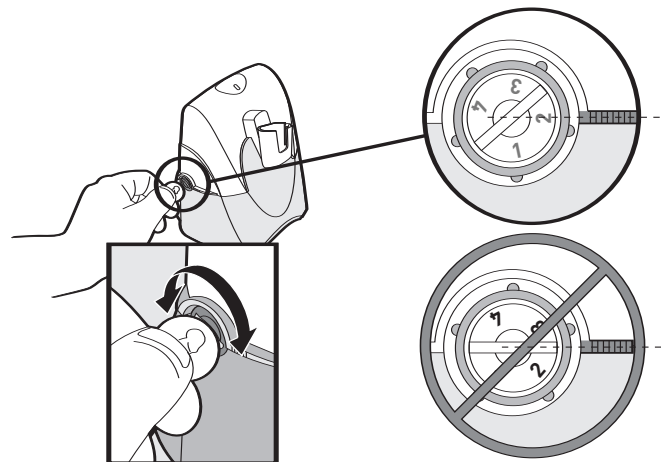

Adjust your telephone configuration dial on the base to position 3 for the following telephones: 2420, 4610SW, 4620, 4620SW, 4621SW, 4622SW, 4625SW, 4630SW, 5420, 5610, 5620, 7403D, 7405D, 7407D, 7406, 8403, 8405, 8410D, 8411D, 8434, 8510ISDN, and 7506ISDN.

Adjust the configuration dial to position 1 for the following telephones: 2410, 4630, 5410, 6416D+M, 6424D+M, and 9600 series.

If you cannot hear a dial tone through your headset, use a coin or small screwdriver to turn the telephone configuration dial until you can. **Make sure that a number is aligned with the position indicator.**

1. Place a call to someone you know.
2. While speaking, turn the configuration dial through the four positions.
3. Select the position that provides the best sound quality for both you and the recipient.



# Listening Volume

*NOTE: Be sure to set your telephone's volume at the mid range before adjusting the AWH75 volume.*

## Minor Adjust

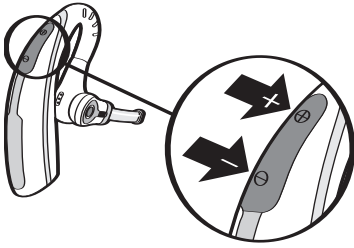

Push on the "+" and "-" buttons to adjust listening volume in minor incremental adjustments.

*NOTE: You must be in talk mode (i.e. on a call) to adjust.*

## Major Adjust

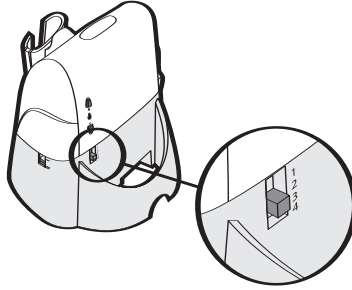

Use listening volume major adjust control on the back of the base for large incremental adjustments.

*NOTE: 1 is the loudest setting.  
4 is the lowest setting.*

## Headset Mute

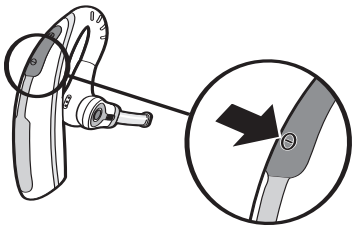

To mute headset, long press the volume down button (3 seconds). Press again to unmute.

Talk indicator light on base will flash while muted.

You will hear 3 rapid beeps every 30 seconds to indicate that mute is on.

# Speaking Volume

## Minor Adjust

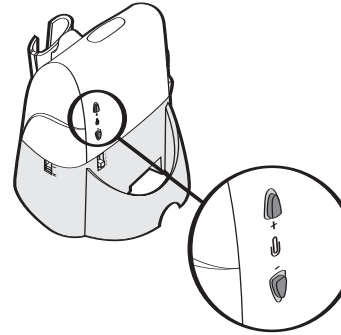

Use the speaking volume minor adjust control on the back of the base for minor incremental adjustments.

*NOTE: You must be in talk mode (i.e. on a call) to adjust.*

## Major Adjust

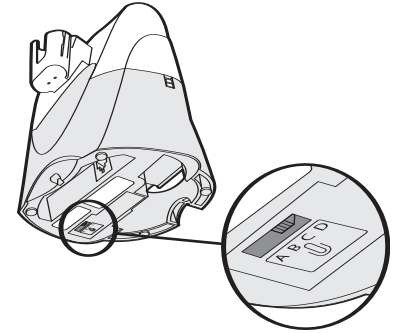

Use the speaking volume major adjust control on the bottom of the base for large incremental adjustments.

*NOTE: A is the lowest setting.  
B is the most common setting.  
D is the loudest setting.*

# Headset Controls

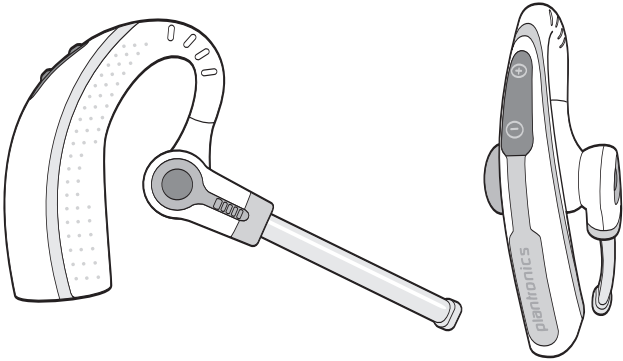

Feature	Action	Tone
Listening volume minor adjust	Press + to increase or - to decrease	Ascending/descending tones, 2 tones at limit
Mute	Long press - key (3 seconds)	3 mid tones = Mute 3 low tones = Unmute <i>NOTE: Tones repeat every 30 seconds when muted.</i>
Answering/ending calls	Short press call control button	Mid tone
Low battery warning	Replace headset in charging cradle	1 tone every 10 seconds
N/A	Out of range warning — when on active call	Move closer to base 2 tones
N/A	Incoming call notification*	Press call control button to answer call 3 repetitive tones

\* Only works when using optional Handset Lifter.

# Base Indicator Lights

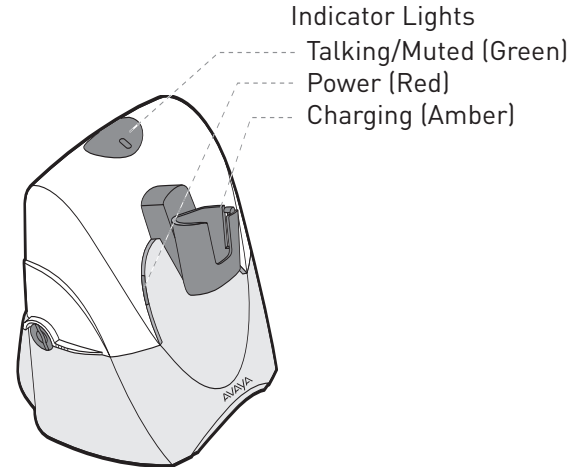

Action	Light
Charging	Flashes amber
Fully Charged	Solid amber
Power	Solid red
Talking	Solid green
Muted	Flashes green

# Troubleshooting

Problem	Solution
<b>I plugged everything in but the lights won't come on.</b>	<ul style="list-style-type: none"> <li>• Check that the AC charger jack is connected to the base unit.</li> <li>• Check that the AC charger is securely connected to a working wall outlet.</li> <li>• Check that the AC charger is the model supplied by Avaya.</li> </ul>
<b>My headset does not work with the base unit.</b>	<ul style="list-style-type: none"> <li>• Check that the phone is connected to the base unit's phone cord jack and it is pushed in firmly.</li> <li>• Check that the phone handset is connected to the base's phone handset jack and it is pushed in firmly.</li> <li>• Headset may be out of range of the base. Move closer to base unit until headset is within range. Range varies with office environment.</li> <li>• Headset battery is dead. Recharge the battery by placing the headset in the headset charging cradle. See page 11.</li> <li>• Listening volume too low. Press the volume up button on the headset. If the volume is still too low, select another listening volume major adjust switch setting. See page 16.</li> <li>• Incorrect configuration dial setting for your phone. Try other phone configuration dial settings on the base unit. Ensure the selected number is in line with the position indicator. See page 15.</li> <li>• You may have to resubscribe your headset with the base. See page 22.</li> </ul>
<b>Callers cannot hear me.</b>	<ul style="list-style-type: none"> <li>• Headset is muted. Press the mute button on headset to unmute the microphone. See page 16.</li> <li>• Speak volume is too low. Increase the speaking volume by adjusting the speaking volume minor adjust buttons on the base unit as described on page 17. If the volume is still too low, select another speaking volume major adjust setting as described on page 17.</li> <li>• Incorrect configuration dial setting for your phone. Try other phone configuration dial settings on the base unit. Ensure the selected number is in line with the position indicator. See page 15.</li> </ul>
<b>I can hear a dial tone in more than one configuration position.</b>	Phone will work in more than one configuration dial position. Use the position that sounds best to you and the person you call.
<b>I cannot hear a dial tone in any configuration position.</b>	<ul style="list-style-type: none"> <li>• Check that the phone is connected to the base's phone cord jack. See pages 6–10.</li> <li>• Check that the phone handset is connected to the base's phone handset jack. See pages 6–10.</li> </ul>
<b>I cannot hear caller/dial tone.</b>	<ul style="list-style-type: none"> <li>• Check that all cords and jacks are connected correctly.</li> <li>• Check that the base has power (red indicator light) and the headset battery is fully charged.</li> <li>• Try other phone configuration dial settings on the base unit. Ensure the selected number is in line with the position indicator. See page 15.</li> <li>• Ensure you are in headset mode. Press the talk button to select correct mode. The talk indicator light on the base is green.</li> </ul>

# Troubleshooting

Problem	Solution
<b>Sound in headset is distorted/hear echo in headset.</b>	<ul style="list-style-type: none"> <li>• Reduce speaking volume by changing the speaking volume major adjust switch setting. See page 17.</li> <li>• Point microphone towards your chin.</li> <li>• Listening volume too high on phone. If your phone has a headset volume control, lower this until the distortion disappears.</li> <li>• If the distortion is still present, lower the listening volume adjust button on the headset. If the distortion persists, select another listening volume major adjust switch setting. See page 16.</li> <li>• Base is too close to computer or phone. See page 11 for proper positioning.</li> <li>• System needs to be reset. Perform system reset as described on page 22.</li> </ul>
<b>I can hear too much background conversation, noise or sidetone.</b>	Speaking volume is too high. Lower the speaking volume by adjusting the speaking volume minor adjust buttons on the base. If the volume is still too high, select another speaking volume major adjust setting. See page 17.
<b>People I talk to can hear a buzz in the background.</b>	<ul style="list-style-type: none"> <li>• AC charger is plugged into a power strip. Plug the AC charger into the wall directly.</li> <li>• Picking up another radio frequency. Call the Avaya Headset Helpdesk for an RF filter.</li> </ul>
<b>Battery talk time performance is significantly degraded even after a full recharge.</b>	Battery is going bad. Replace the battery with a new battery pack. See page 23.
<b>The call is dropped. (Talk indicator on the headset and base will not be illuminated.)</b>	Headset lost subscription. Try to reset the system. See page 22. If this does not work, try the resubscription procedure on page 22.
<b>I hear static that does not allow me to communicate.</b>	<ul style="list-style-type: none"> <li>• Link to headset is lost. Try to reestablish a link by pressing the headset talk button.</li> <li>• Unplug the AC charger from the base for 7 seconds, then plug back in.</li> <li>• Reset the whole system as described on page 22.</li> </ul>
<b>I hear beeps in the headset.</b>	<ul style="list-style-type: none"> <li>• One beep every 10 seconds is caused by a low battery warning. Recharge battery by returning it to the base charge cradle for one to three hours until charge light stays lit or quits blinking.</li> <li>• Two beeps is an out of range warning. Move closer to the base.</li> <li>• Three rapid beeps every 30 seconds indicates your mute is on. Press the mute control dial once to turn mute off.</li> <li>• When an optional filter is connected, three repetitive beeps indicate a call is coming into the headset. Press the talk button on the headset to answer the call.</li> </ul>
<b>Headset lifter is installed but does not lift handset.</b>	Be sure the handset lifter power cord is firmly pushed into the handset lifter jack on the base.
<b>My handset lifter operates every time I remove or replace my headset in the base unit.</b>	IntelliStand is enabled. To disable the handset lifter, move the IntelliStand switch to position —.

## Subscription

---

The headset and base unit are supplied subscribed to each other. However, if you wish to use a replacement headset with the base unit, then the units must be re-subscribed. To do so, please follow the instructions on page 12 for Multi-Shift Pairing.

## System Reset

---

To recover from some fault conditions (refer to the Troubleshooting Section), you may need to perform a system reset. To perform the system reset, follow this procedure:

---

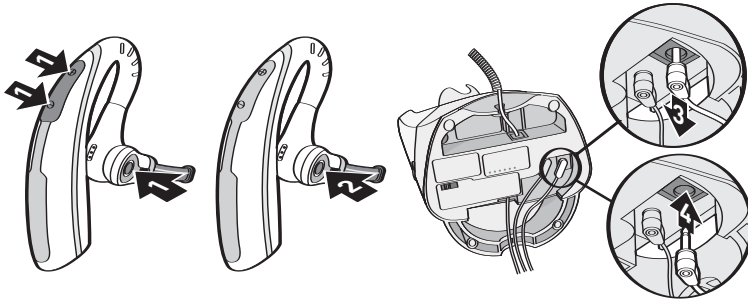

1. Simultaneously press the call control button and both the "+" and "-" volume buttons for 5 seconds. When the talk indicator light on the headset blinks, release all buttons.
2. Press the call control button again. The talk indicator light will again blink briefly to indicate the headset is back to normal operation mode.
3. Disconnect the AC charger from the AC charging jack for 5 seconds.
4. Reconnect.

The system reset operation is complete.

## Maintenance

---

1. Replace voice tube every 6-9 months (voice tube models only).
2. Unplug the unit from the telephone and the AC charger from the power source before cleaning.
3. Clean the equipment with a damp (not wet) cloth.
4. Do not use solvents or other cleaning agents.

## Battery Replacement

---

The custom battery supplied should last 2-3 years. When talk time decreases significantly, you should replace the battery. Call Plantronics at (800) 544-4660 ext. 5538 for information on sending back to factory to install new battery.

---

# Accessing the Avaya Unified Communication Center (UCC) from the AWH75

---

1. Connect the AWH75 to the Avaya telephone. Follow the instructions in this user guide.
2. Ask your switch administrator to configure your telephone for ringdown to the UCC in your telephone first call appearance.\*

\* Notes for switch administrators on configuring ringdown for your AVAYA telephones:

- Some phones allow for direct ringdown configuration, i.e. 2500.
- Other phones do not allow for direct ringdown configurations, i.e. 64XX. In order to configure the ringdown in these phones, the administrator needs to:
  - Create a phantom extension setup as a 2500 type.  
[No real port has to be assigned.]
  - Create a ringdown to the UCC for the phantom extension.
  - Bridge the phantom extension to the telephone call appearance 1 [configure it as an "abrdg-appr" and setup the "Auto Select Any Idle Appearance" to Yes].

# Technical Assistance

---

The Avaya Headset Helpdesk is ready to assist you! Dial (800) 544-4779, or visit the support section of our website at [www.avayaheadsets.com](http://www.avayaheadsets.com).

## Regulatory Notices

---

### FCC Requirements – Part 15

This device complies with Part 15 of the FCC Rules. Operation is subject to the following two conditions:

1. This device may not cause harmful interference, and
2. This device must accept any interference received, including interference that may cause undesired operation.

This equipment has been tested and found to comply with the limits for a Class B digital device, pursuant to Part 15 of the FCC Rules. These limits are designed to provide reasonable protection against harmful interference in a residential installation. This equipment generates, uses, and can radiate radio frequency energy and, if not installed and used in accordance with the instructions, may cause harmful interference to radio communications. However, there is no guarantee that interference will not occur in a particular installation. If this equipment does cause harmful interference to radio or television reception which can be determined by turning the radio or television off and on, the user is encouraged to try to correct interference by one or more of the following measures:

1. Reorient or relocate the receiving antenna.
2. Increase the separation between the equipment and receiver.
3. Connect the equipment into an outlet on another circuit.
4. Consult the dealer or an experienced radio/TV technician for help.

### FCC Requirements – Part 68

This equipment complies with Part 68 of the FCC rules and the requirements adopted by ACTA. On the exterior of this equipment is a label that contains a product identifier in the format US:AAAEQ##TXXXX. If requested, this information must be provided to your telephone company.

A plug and jack used to connect this equipment to the premises wiring and telephone network must comply with the applicable FCC Part 68 rules and requirements adopted by ACTA. A compliant telephone cord and modular plug is provided with this product. It is designed to be connected to a compatible jack that is also compliant. See installation instructions for details.

The REN is useful to determine the quantity of devices you may connect to your telephone line. Excessive RENs on a telephone line may result in the devices not ringing in response to an incoming call. In most, but not all areas, the sum of the RENs should not exceed five (5.0). To be certain of the number of devices you may connect to your line, as determined by the REN, contact your local telephone company. For product approved after July 23, 2001, the REN for this product is part of the product identifier that has the format US:AAAEQ##TXXXX. The digits represented by ### are the REN without the decimal point. [For example, 03 represents a REN of 0.3.] For earlier producers, the REN is separately shown on the label.

If this telephone equipment causes harm to the telephone network, the telephone company will notify you in advance that temporary discontinuance of service may be required. But if advance notice isn't practical, the telephone company will notify the customer as soon as possible. Also, you will be advised of your right to file a complaint with the FCC if you believe it is necessary.

The telephone company may make changes in its facilities, equipment, operations, or procedures that could affect the proper functioning of your equipment. If they do, you will be notified in advance in order for you to make necessary modifications to maintain uninterrupted service.

If trouble is experienced with this unit, for repair or warranty information, please contact customer service at (800) 544-4779. If the equipment is causing harm to the network, the telephone company may request that you disconnect the equipment until the problem is resolved.

**DO NOT DISASSEMBLE THIS EQUIPMENT:** it does not contain any user serviceable components.

We recommend the installation of an AC surge arrester in the AC outlet to which this equipment is connected. Telephone companies report that electrical surges, typically lightning transients, are very destructive to customer terminal equipment connected to AC power sources.

### Exposure to RF Radiation

The internal wireless radio operates within the guidelines found in radio frequency safety standards and recommendations, which reflect the consensus of the scientific community. Independent studies have shown that the internal wireless radio is safe for use by consumers. Visit [www.avayaheadsets.com](http://www.avayaheadsets.com) for more information.

**NOTE:** Modifications not expressly approved by Avaya could void the user's authority to operate the equipment.